



2SA1103

PNP PLANAR SILICON TRANSISTOR

AUDIO POWER AMPLIFIER DC TO DC CONVERTER

- High Current Capability
- High Power Dissipation
- Complementary to 2SC2578

ABSOLUTE MAXIMUM RATING (T_A=25°C)

Characteristic	Symbol	Rating	Unit
Collector-Base Voltage	V _{CB0}	-100	V
Collector-Emitter Voltage	V _{CEO}	-100	V
Emitter-Base voltage	V _{EB0}	-6	V
Collector Current (DC)	I _C	-7	A
Collector Dissipation	P _C	70	W
Junction Temperature	T _j	150	°C
Storage Temperature	T _{stg}	-55~150	°C

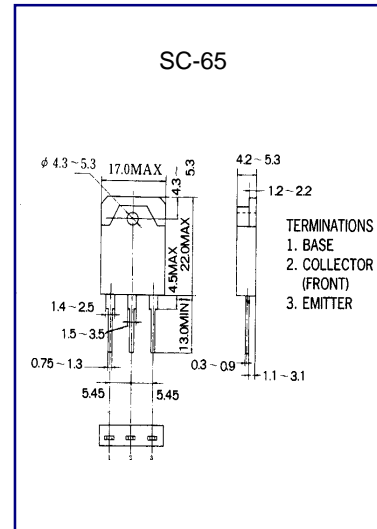

ELECTRICAL CHARACTERISTICS (T_A=25°C)

Characteristic	Symbol	Test Condition	Min	Typ	Max	Unit
Collector Base Breakdown Voltage	BV _{CB0}	I _C =-5 mA I _E =0	-100			V
Collector Emitter Breakdown Voltage	BV _{CEO}	I _C =-10 mA R _{BE} =∞	-100			V
Emitter Base Breakdown Voltage	BV _{EB0}	I _E =-5mA I _C =0	-6			V
Collector Cutoff Current	I _{CB0}	V _{CB} =-60V I _E =0			-0.1	mA
Emitter Cutoff Current	I _{EB0}	V _{EB} =-4V I _C =0			-0.1	mA
*DC Current Gain	h _{FE1}	V _{CE} =-5V I _C =-1A	55		160	
DC Current Gain	h _{FE2}	V _{CE} =-5V I _C =-3A	80			
Collector- Emitter Saturation Voltage	V _{CE(sat)}	I _C =-3A I _B =-0.3A			-1.5	V